

The Distributed KVM-over-IP Solution

SecureLinx
Spider™

Connect. Communicate. Control.

LANTRONIX®

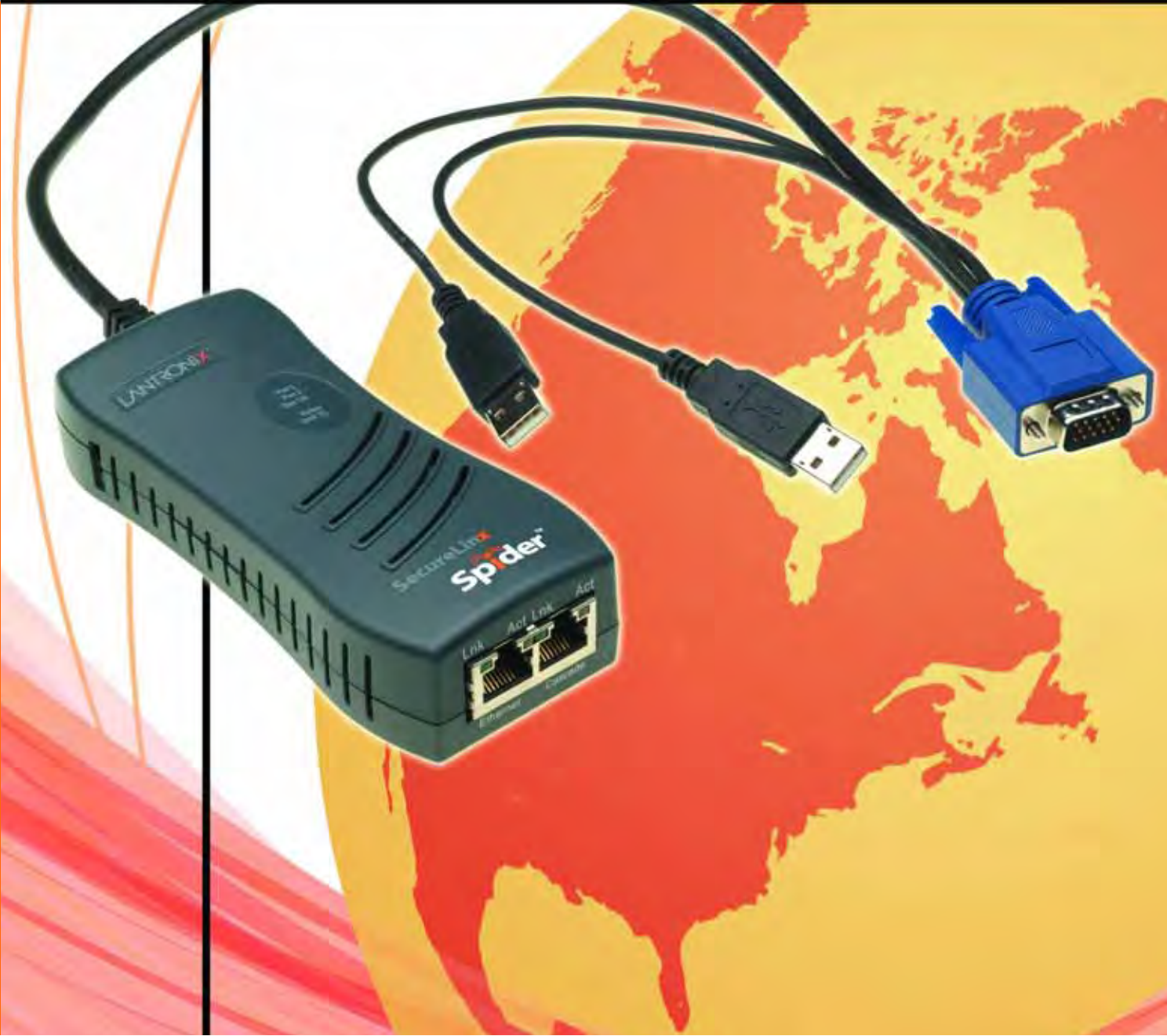

The Distributed KVM-over-IP Solution



SecureLinX
Spider™

The Next Generation of KVM

- Full non-blocked access providing one of the lowest "cost-per-remote-user" server management solutions available
- Secure, full BIOS-level control of servers over an IP network
- Clean, flexible CAT5 KVM solution with virtually no cable length restrictions
- Completely integrated IP-based KVM switch in a "Zero U" form factor
- Cost-effective and easy "add-as-you-grow" scalability by daisy-chaining multiple units
- Compact server-powered design – no external power supply required
- Virtual Media support
- Browser-based – no client software required
- Each unit supports up to 8 simultaneous users
- Remote Authentication support, including LDAP, RADIUS, and Active Directory

Features – SecureLinx Spider

Security

- Secure encryption of keyboard, mouse and video data
- IP Source Address Filtering
- Remote Authentication: LDAP, RADIUS, Active Directory
- User/Group management with permissions control
- Configurable port numbers (HTTP, HTTPS, Telnet, SSH)
- Selective disable of Telnet/SSH

Target Server Requirements

- Supports Multiple Operating Systems: Windows 98/2000/2003/XP/ Vista, Unix, Linux, or MAC OS X 10
- Power/keyboard/mouse: 2 USB ports; or 1 USB, 1 PS/2 keyboard, and 1 PS/2 mouse connector
- Video Interface: HD15 VGA video output (up to 1280x1024@60Hz)

Client System Requirements

- Internet Explorer 6.0+, Netscape 5.0+, Mozilla 1.0+, Firefox 1.0+, Safari 2.0+
- PIII Processor equivalent or better (recommended)
- Sun Java 2 Runtime Environment
- Telnet/SSH client for command line (CLI) access

Interfaces

- Network: One 10/100Base-T Ethernet Port with activity indicators (RJ45)
- Cascade: One 10/100Base-T Ethernet Port with activity indicators (RJ45)
- Serial: RS-232, up to 115,200 bps
- Keyboard/Mouse: PS/2 or USB
- Video: HD15 VGA

Environmental

- Operating: 0° to 45° C (32° to 115° F)
- Storage: -20° to 70° C (-4° to 158° F)
- Humidity: 0 to 95% RH (non-condensing)
- Heat Dissipation: 4 Watts (14 BTU/hr)

Power Requirements

- Input: 5 VDC @ .8A max. (server powered)
- Optional Auxiliary DC power supply available for redundancy (p/n: 520-085-R)

Certifications

- UL/CUL (CSA-22.2 No. 60950-1-03 / UL-60950-1)
- CE - IEC 60950-1
- C-Tick
- FCC Part 15, Equipment Class A
- VCCI V-3/2006.04 Class A
- AS/NZS CISPR 22: 2006 Class A
- EN55022:1998 + A1:2000 + A2:2003 Class A
- EN61000-3-2: 2000 + A2: 2005 Class A
- EN61000-3-3: 1995 + A1: 2001
- EN55024: 1998 + A1:2001 + A2:2003
- RoHS Compliant (lead free)

Warranty

- 2 year limited warranty

Physical

- Spider Unit Dimensions: (H x W x D) 13.2 x 5.8 x 3.1 cm (5.2 x 2.3 x 1.2 in)
- Weight: 185g (6.6 oz)
- Shipping Weight: .5 kg (1.0 lbs)

Ordering Information

Part Number	Description
SLS200USB0-01	1 Port Remote KVM-over-IP with USB Connectors; 21" VGA cable
SLS200PS20-01	1 Port Remote KVM-over-IP with PS/2 and USB Connectors; 21" VGA cable
SLS200USBx0-01	1 Port Remote KVM-over-IP with USB Connectors; 58" VGA cable
SLS200PS2x0-01	1 Port Remote KVM-over-IP with PS/2 and USB Connectors; 58" VGA cable
520-085-R	Optional DC Power Supply with International Adapters (100-240VAC, 50-60 Hz; 5 VDC @ 1A; USB "mini-B" type jack)
083-015-R	Replacement Mounting Bracket Kit

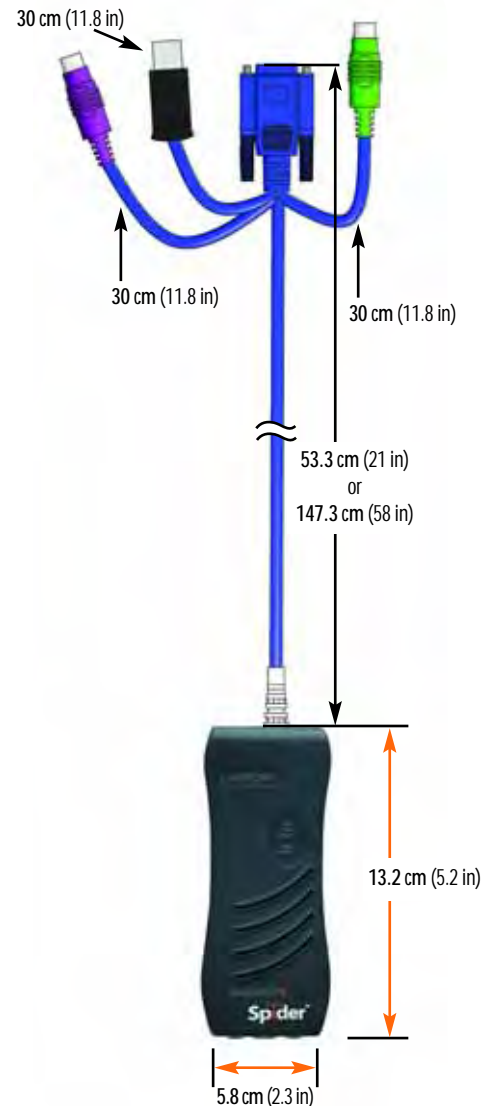
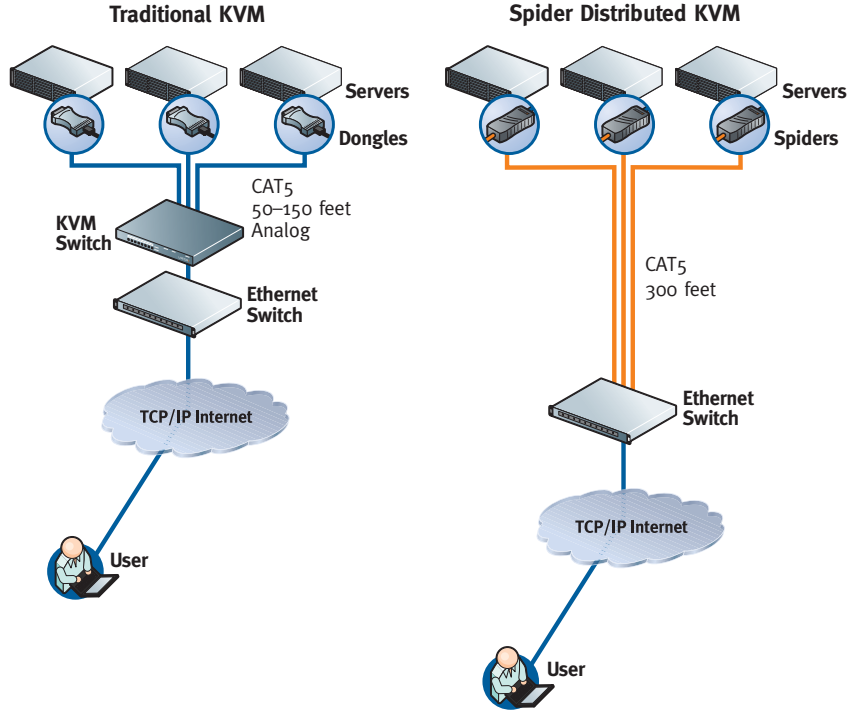

The Next Generation KVM-over-IP

Distributed KVM for the Global IT Environment

SecureLinx Spider™ provides secure KVM (keyboard, video, mouse) server management over an IP network. Unlike any other product on the market, Spider offers a flexible, scalable and affordable CAT5-based remote access KVM solution in a cable friendly, compact "zero-footprint" package.

Spider is ideal for remotely managing geographically distributed IT equipment. It eliminates server-to-switch CAT5 cable distance limitations and gives system administrators 24/7 access to mission-critical servers distributed across a wide variety of network environments such as high-density data centers, corporate or university campuses, multi-floor buildings, branch offices, and test and development labs.

Connected directly to the server, Spider guarantees non-blocked access from any web browser, anywhere, at any time! More cost-effective than traditional KVM, it provides one of the lowest "cost-per-remote-user" server management solutions available. And no client software or external power supply is required.

Amazingly scalable, Spiders can be easily daisy-chained together using Lantronix SwitchPort+™ integrated Ethernet switch technology. This provides an economical and highly flexible solution in environments where numerous cable drops and distance limitations can be a challenge when adding servers.



SecureLinx
Spider™

Access Servers Anytime, from Anywhere – No Cable Distance Restrictions

KVM over IP switches are a valuable part of an effective infrastructure management strategy, enabling administrators to gain BIOS-level access to servers, perform maintenance and solve problems from virtually anywhere at a moment's notice – regardless of location. However, the cable distance limitation between servers and a KVM switch present a problem. In a "distributed IT" environment a better solution is needed.

SecureLinx Spider provides secure KVM access to servers over a standard IP network. It does not have the cable-length restrictions inherent with computer interface modules (CIMs) and current CAT5 KVM switches. Servers can be across the room or across the globe! Video degradation is not a factor, and additional cable drops are not necessary.

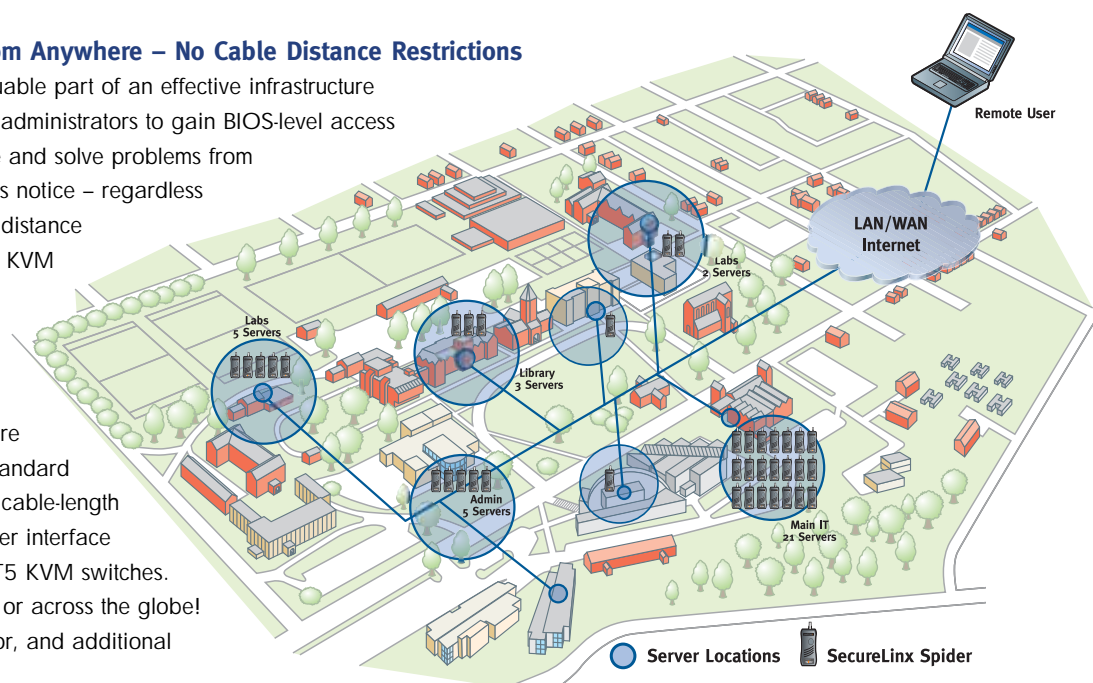

Distributed IT Environment

Fully Secure, Non-Blocked Remote Access

SecureLinux Spider provides continuous availability to servers with 1:1 non-blocked access. This allows administrators to have guaranteed access to mission-critical servers, regardless of how many of them need remote access. In other words, administrators are not locked in to a fixed number of remote users. And adding more remote users is simple and cost effective – just add another Spider!

Additionally with Spider, you can add remote IP users one server port at a time, rather than adding another switch that provides costly, pre-defined multiples. And there is no single point of failure with Spider deployments. If a unit is disabled, you lose access to just one server and the Spider is easily replaced.

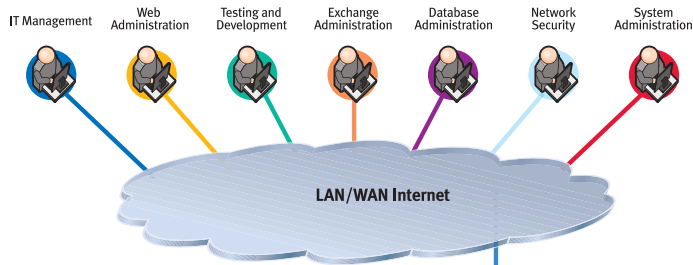

24/7/365 non-blocked server access

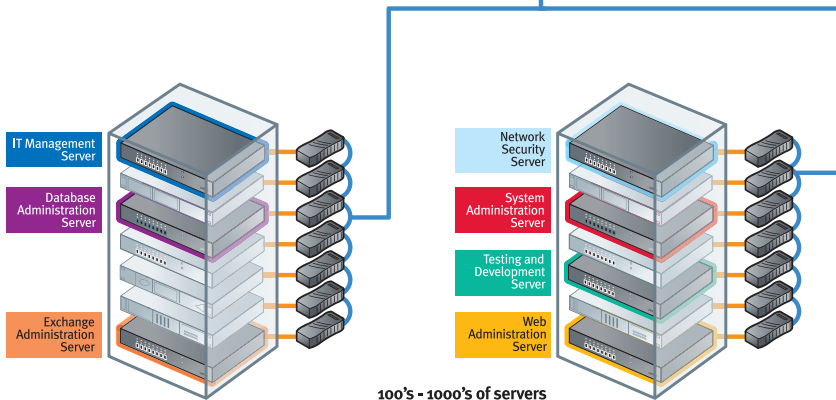

100's - 1000's of servers

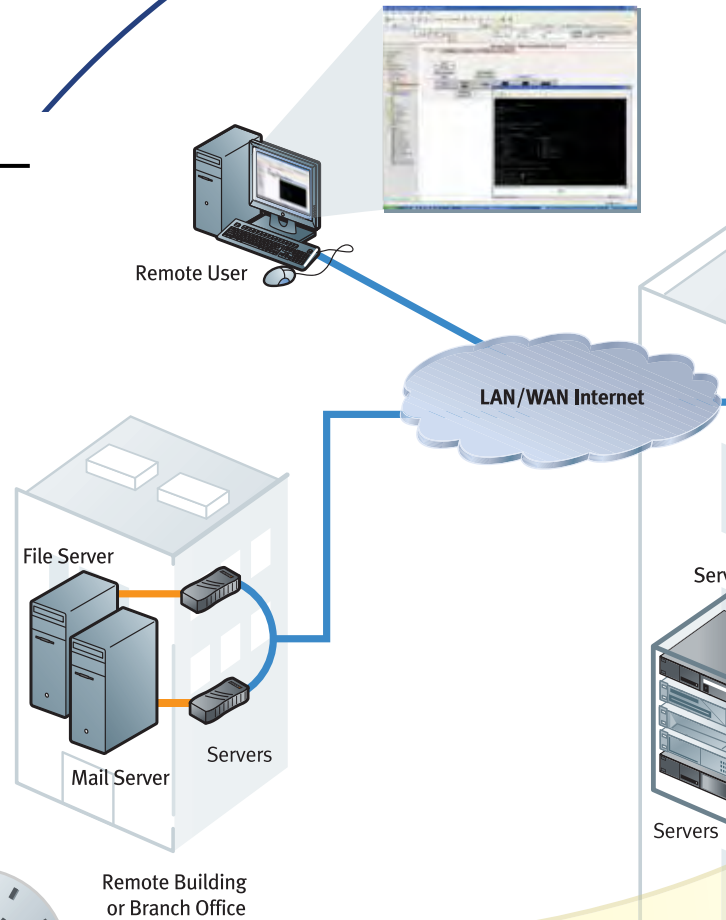

Remote Building or Branch Office

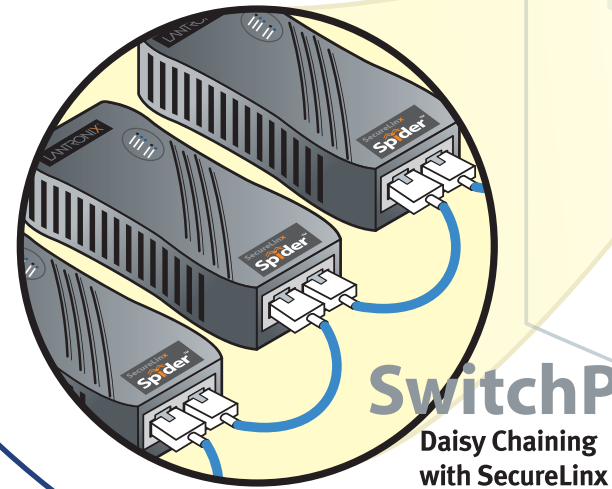

Small Size, Big Performance... and No External Power Required

This unique Lantronix innovation is a fully-integrated, digital IP-based KVM switch. And it has all the capabilities of a traditional KVM switch – all in a miniaturized, zero-footprint package! About the size of a small chalkboard eraser and weighing about 6 oz., Spider does not consume any valuable rack space and is light enough to be cable-supported from the back of a server.

Available in USB and PS2 models, the unique low-power design enables Spider to be powered directly from the attached server, with no external power supply required.* A redundant power supply option is available. (See order information table.)

* In cases where the target server can not supply enough power to Spider, or power is not persistent through reboots, the optional power supply may be required.



Unique Design & Flexibility

The Ultimate in Flexibility and Scalability

Spider's unique dual-Ethernet port design takes advantage of Lantronix SwitchPort+ integrated Ethernet switch technology. SwitchPort+ enables flexible, cost-effective add-as-you-grow scalability by cascading multiple units together through a single Ethernet connection. This allows all OOB interfaces to be accessed from one IP connection with superior video quality and exceptional mouse tracking performance. Best of all, it requires no client software.

As part of the SecureLinX family of products, Spiders can be easily integrated into a total remote OOB management strategy including serial console management (award-winning SecureLinX SLC), remote power management (SecureLinX SLP), and consolidated management access including auto-discovery, access control and logical device grouping (SecureLinX SLM).

It's also an ideal complement to a traditional KVM switch. By adding a Spider to the local port of an existing analog KVM switch, administrators gain all the advantages of remote access without having to replace their current equipment.

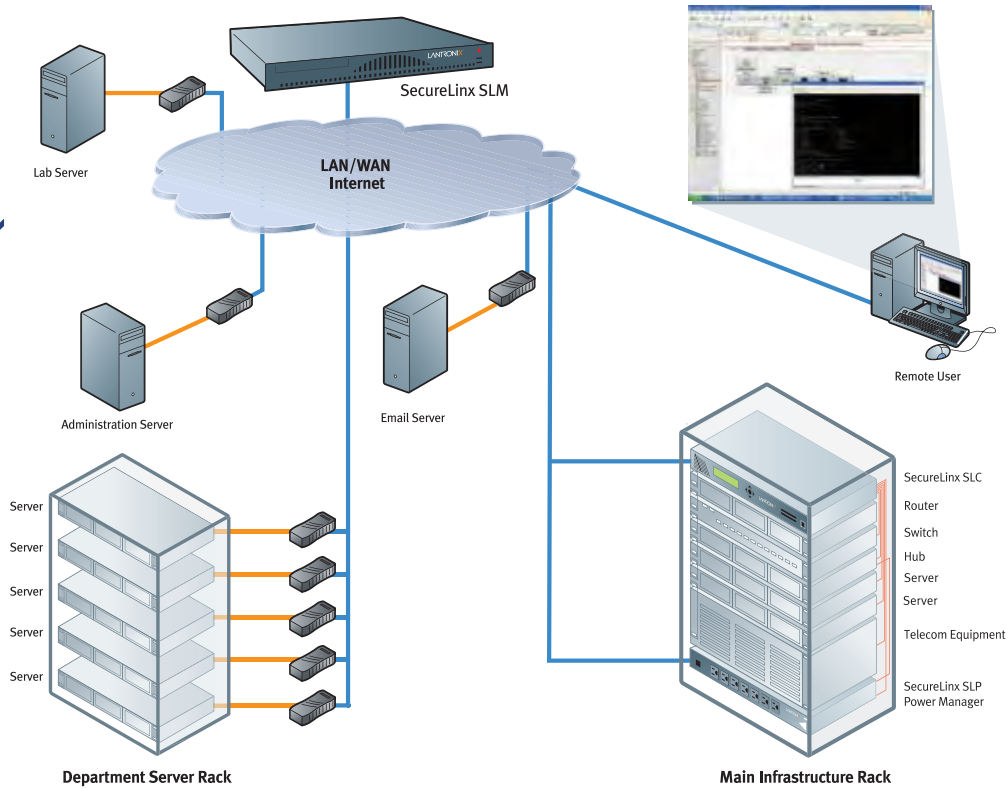
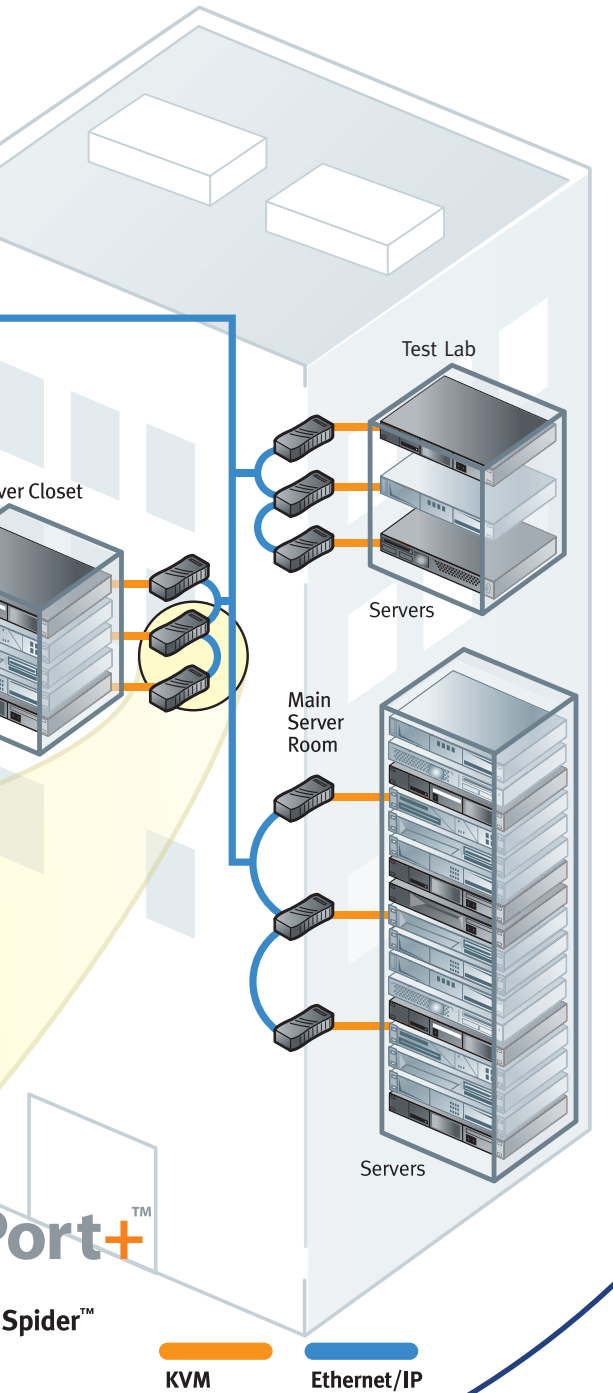

SecurelinX Spider can easily be integrated into a total OOB strategy and given total consolidated access with SecurelinX SLM.

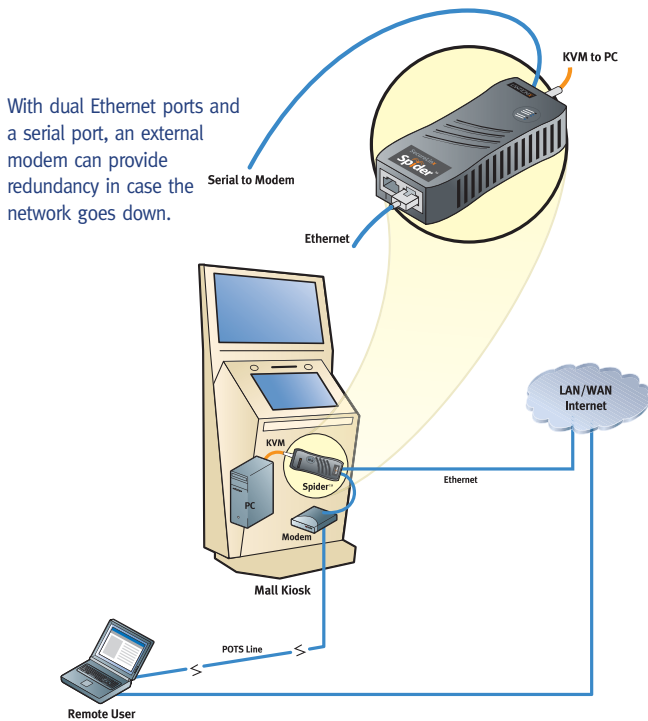

Powerful & Secure

All the Power You Need – In a Tiny Package

Spider features a powerful ARM based processor, on-board memory (Flash, Video and CPU SDRAM), secure operating system, web server and intelligent power management. It also includes a video encoder and embedded Ethernet switch with built-in support for Virtual Media. Spider integrates a serial interface and second Ethernet port, allowing hardware connections to all commonly used out-of-band management interfaces.

The internal processor provides data translation and packetizing so users may access any or all OOB interfaces via one Ethernet connection.

- Hardware-based compression algorithm ensures exceptional video performance and low bandwidth consumption
- VESA standard video support resolution up to 1280 x 1024 @ 60Hz
- Automatic video resolution detection with manual setting capability for support of non-standard video formats
- Exceptional mouse synchronization and video performance
- Serial data rates up to 115200 baud – supports an external modem for out-of-band access

SecureLinX Spider Applications

SecureLinX Spider is designed primarily for managing mission-critical servers and equipment in a distributed environment.

- Campus environments (corporate and education)
- Branch offices
- Remote sites
- Isolated servers
- Distributed IT infrastructures (multi-floor, multi-building, multi-site)
- In the laboratory: computer test labs, call centers, help desks, training rooms
- Test and development
- Departmental IT
- Disaster recovery sites
- SMBs
- Government facilities
- Dark data center facilities
- Convention centers
- Corporate offices
- Kiosks
- Factories
- Enterprise data centers

Software, Security and Management features

- Full BIOS-level control of the attached server
- Virtual Media Support
- RADIUS, LDAP and Active Directory remote authentication support
- Secure encryption of keyboard, mouse, and video data
- User-definable groups with multilayer users and passwords
- Serial administration console port (RS-232) supports Telnet and SSH tunneling to a server COM port
- Event Log to NFS server, E-mail (SMTP), SNMP destination IP
- Firmware upgradeable via web browser
- User configurable hot keys
- Spider View – optional Windows® client management utility included

Distributed KVM vs. High-Density KVM

High-Density KVM Solution	SecureLinX Spider
34 servers may require two 32-port KVMs or some combination that leaves unused ports, increasing the cost per port.	With Spider, you can add one port at a time.
If a 32-port KVM unit fails, all access to those connected servers is lost.	If a unit is disabled you lose access to just one server; and Spider is easily replaced.
If access to all 32 servers is through a single Ethernet connection and the switch port fails, access to all 32 servers is lost.	Spiders can be cascaded or connected individually back to a switch. They can even be distributed among multiple switches so no single switch failure cuts you off from all your servers.
Most high-density solutions require purchasing dongles to connect to managed servers, increasing cost.	Spider has the necessary HD-15 video, USB and PS/2 connections built in.
A typical high-density solution allows access to a limited number of managed servers at a time. (A high-end 32-port KVM may only allow as many as 8 servers to be accessed at once.)	Each Spider allows one or more people to connect to a server. 32 Spiders means 32 simultaneous non-blocking connections – <i>multiple users can access the attached server simultaneously!</i>
Most CAT5-based solutions are limited to 50 to 150 feet between the switch and server. And image quality degrades with distance.	With Spider, there are virtually no cable limitations and image quality doesn't degrade with distance.
Switch-based solutions may require separate KVM and serial dongles and/or external power supplies.	Spider is a completely integrated IP-based KVM switch that does not require an external power supply.



The Leader in Remote Management for Distributed IT

As a worldwide leader in secure remote management, Lantronix data center solutions are trusted by Fortune 100 businesses in virtually every sector, the top telcos and leading financial institutions. With the highest levels of security for out-of-band access, our robust product offering can help ensure that if your data center goes down, you can still reach and repair your equipment, no matter where you are.

Visit www.lantronix.com or call our sales support team at **(800) 422-7055** to schedule a demonstration and find out how quickly and easily SecureLinX can add an unprecedented level of reliability to your business-critical equipment.

www.lantronix.com

CORPORATE HEADQUARTERS

15353 Barranca Parkway
Irvine, CA 92618 USA
Tel: 800.422.7055
Fax: 949.450.7232
sales@lantronix.com
ftp.lantronix.com

TECHNICAL SUPPORT

Hours: 6:00 am – 5:00 pm PST
Mon-Fri (excluding holidays)
Tel: 800.422.7044 (US only)
Fax: 949.450.7226
www.lantronix.com/support

PREMIER PARTNER PROGRAM

partners@lantronix.com

EUROPEAN HEADQUARTERS

2 Rue Helene Boucher
78280 Guyancourt
France
Tel: +33.1.39.30.41.74
Fax: +33.1.39.30.41.73
europesouth@lantronix.com
eu_sales@lantronix.com
Technical support
+33 (0) 1.39.30.41.72
eu_techsupp@lantronix.com

GERMANY

+49 (0) 8092.85.03.65
europecentral@lantronix.com
Technical support
+49 (0) 180.500.13.53

UNITED KINGDOM

+44 (0) 118.924.2511
europenorth@lantronix.com

THE NETHERLANDS

+31.76.542.6977
europenorth@lantronix.com

LATIN AMERICA & CARIBBEAN

+1.949.453.3990
la_sales@lantronix.com

AUSTRALIA & NEW ZEALAND

+1.949.453.3990
au-nz_sales@lantronix.com

JAPAN

4-41-2
Sasanodai, Asahi-ku
Yokohama, Kanagawa
Japan 241-0816
Tel: +81 45 365 4570
Fax: +81 45 365 4570
japan_sales@lantronix.com

ASIA/PACIFIC

Suite 1905 Lippo Centre Tower 2
89 Queensway Admiralty
Hong Kong
Tel: +852.2918.8277
Fax: +852.2918.8274
asiapacific_sales@lantronix.com

LANTRONIX[®]